

RANGE	CODE	MODEL	FUNCTION
MI - 70	MAMCOOOO360	PL78ET	Plancha 2-in-1

ITEM

Electric plancha 2-in-1 800 mm width top



RANGE	CODE	MODEL	FUNCTION
MI - 70	MAMCOOOO360	PL78ET	Plancha 2-in-1

ITEM

Electric plancha 2-in-1 800 mm width top



TECHNICAL SPECIFICATIONS

WIDTH (mm):	800
DEPTH (mm):	750
HEIGHT (mm):	250
WEIGHT (Kg):	
VOLUME (m ³):	0.4
EL. POWER (kW):	10
VOLTAGE:	VAC400 3N
COOKING ZONES N°:	4
COOKING ZONES DIM. (mm):	690x495 mm
COOKING ZONE DETAILS:	4x 2,5kW
IP GRADE:	IPX5
TEMP. RANGE (°C):	50-350

DESCRIPTION

Electric boiling top with hotplate, in AISI 304 stainless steel. 20/10 pressed steel top with anti-spill front edge, designed for flush alignment with hermetic seal supplied. Top designed to accommodate water column accessory. Hotplate made of stainless steel with hardened chrome contact surface. Maintains heat and reduces heat loss in the environment with considerable energy saving. Recessed hotplate flush with top, with radiused corners and bevelled upper edge, 690x495mm cooking zone, 18 mm thick. Large perimeter channel with opening for run-off to grease collection draw. 4 independent 2,5 kW cooking zones 345x247mm. Thermostatic temperature control for direct cooking from 50 to 280°C, for indirect cooking from 50 to 350°C. Heat control knob shaped to prevent water infiltration, equipped with integral indicator lights for instant recognition of heating and correct operation of the appliance. Hotplates equipped with automatic reset safety thermostat that trips if the appliance is switched on with an unsuitable pan or no pan at all. IPX5 water-resistant rating.



RANGE	CODE	MODEL	FUNCTION
MI - 70	MAMCOOOO360	PL78ET	Plancha 2-in-1

ITEM

Electric plancha 2-in-1 800 mm width top

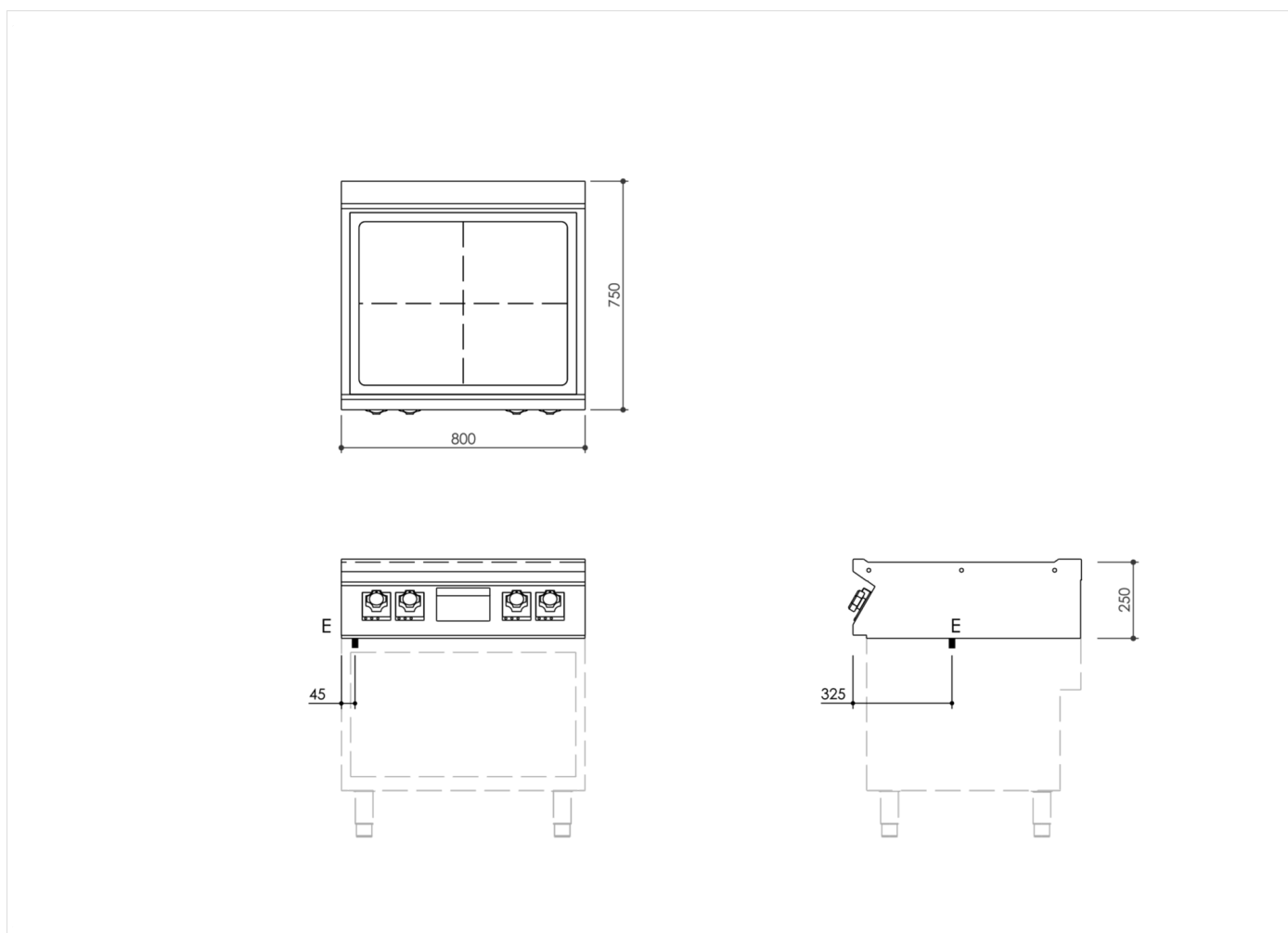

INSTALLATION SPECIFICATIONS

(E) Electrical Connection: VAC400 3N 50/60 Hz

