

RANGE	CODE	MODEL	FUNCTION
MI - 60	CRO853480	B64E	Bain-Marie

ITEM

Electric bain maire 400 width top



RANGE	CODE	MODEL	FUNCTION
MI - 60	CRO853480	B64E	Bain-Marie

ITEM

Electric bain maire 400 width top



**TECHNICAL SPECIFICATIONS**

WIDTH (mm):	400	
DEPTH (mm):	600	
HEIGHT (mm):	295	
WEIGHT (Kg):	15	
VOLUME (m <sup>3</sup> ):	0.1	
EL. POWER (kW):	1	
VOLTAGE:	VAC230	
COOKING ZONES N°:	1	
COOKING ZONE DETAILS:	1 x 1kW	
TANK DIM. (mm):	530x325x200h mm	
TANK N°:	1	CAPACITY (L): 4.5
CONTAINERS MAX N°:	1 x GNI/1	CONTAINERS MAX H: 150mm
IP GRADE:	IPX3	
TEMP. RANGE (°C):	30-90	

**DESCRIPTION**

S/s single-phase electric bain-marie. Deep drawn tank in polished stainless steel with radiused bottom for ease of cleaning. Etched foil heating elements underneath the tank, with thermostatic temperature control from 30°C to 90°C. Product features drain cock. GN compliant tank for 1 x GNI/1 bowls with max. height = 150 mm.



RANGE	CODE	MODEL	FUNCTION
MI - 60	CRO853480	B64E	Bain-Marie

ITEM

Electric bain maire 400 width top

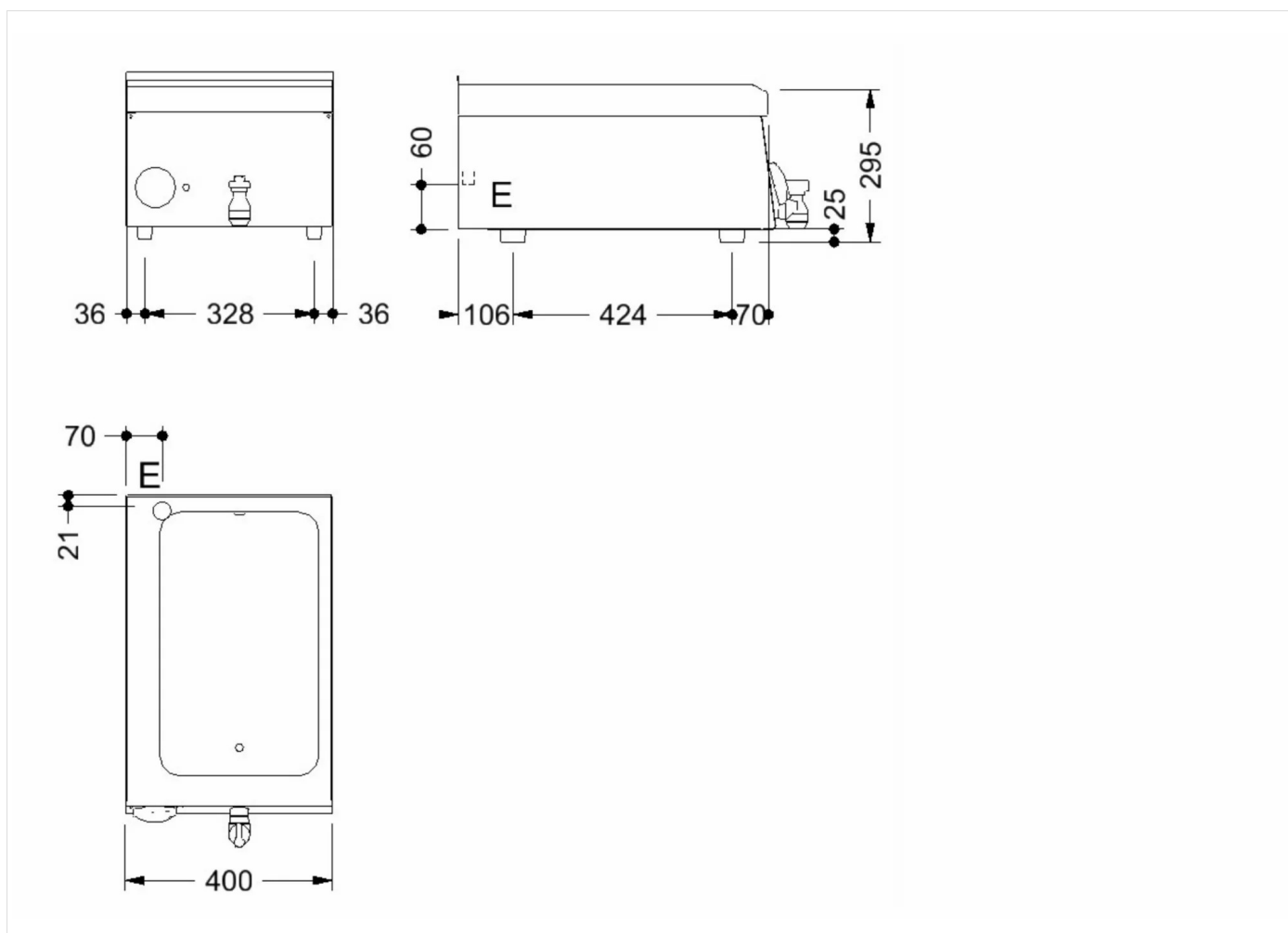

### INSTALLATION SPECIFICATIONS

(E) Electrical Connection: VAC230 50Hz

